

# BARRETT PARK MASTER IMPROVEMENTS PLAN Project Meeting II

March 24, 2022



# Project Team

---

## **Erin McKenna**

Project Manager | City of Stamford

[EMcKenna@StamfordCT.gov](mailto:EMcKenna@StamfordCT.gov)

## **Luke Buttenwieser**

Transportation, Traffic & Parking | City of  
Stamford

## **Kevin Murray**

Operations Manager Parks & Facilities | City  
of Stamford

## **Randall Collins**

Principal Landscape Architect | BETA

## **Jason Ouimet**

Civil Engineer | BETA

## **Nate Socha**

Landscape Architect | BETA

# Project Schedule and Funding

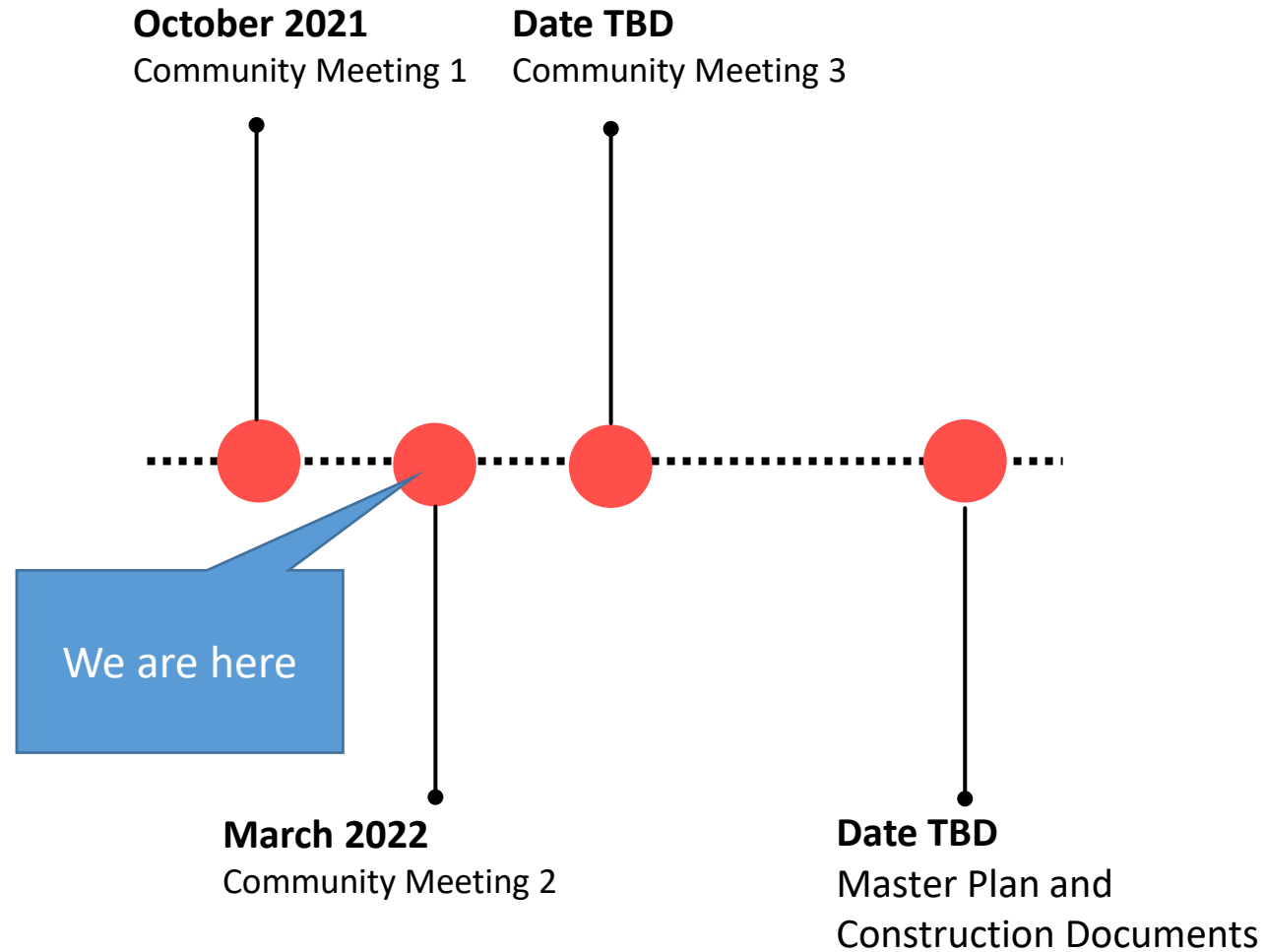

# Agenda

---

- 1. Project Team Introduction**
- 2. Project Overview / Presentation**
  - A. Roadway Improvements**
  - B. Park Improvements**
  - C. Playground Improvements**
- 3. Listening and Discussion**
- 4. Closing Remarks and Next Steps**



# Meeting Protocol

- We ask that everyone remain muted until the end of the presentation.
- After the presentation, we ask that you use the “raise your hand” function to provide feedback.
- We will go through and unmute each person who has their hand raised.
- When unmuted we ask that you state your name

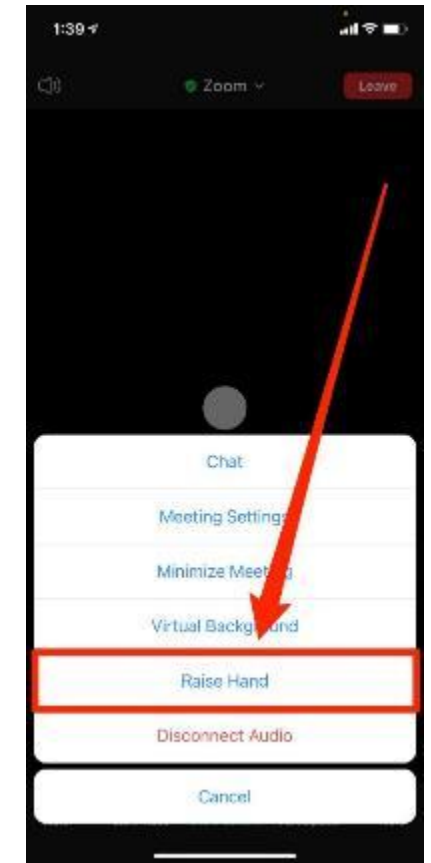
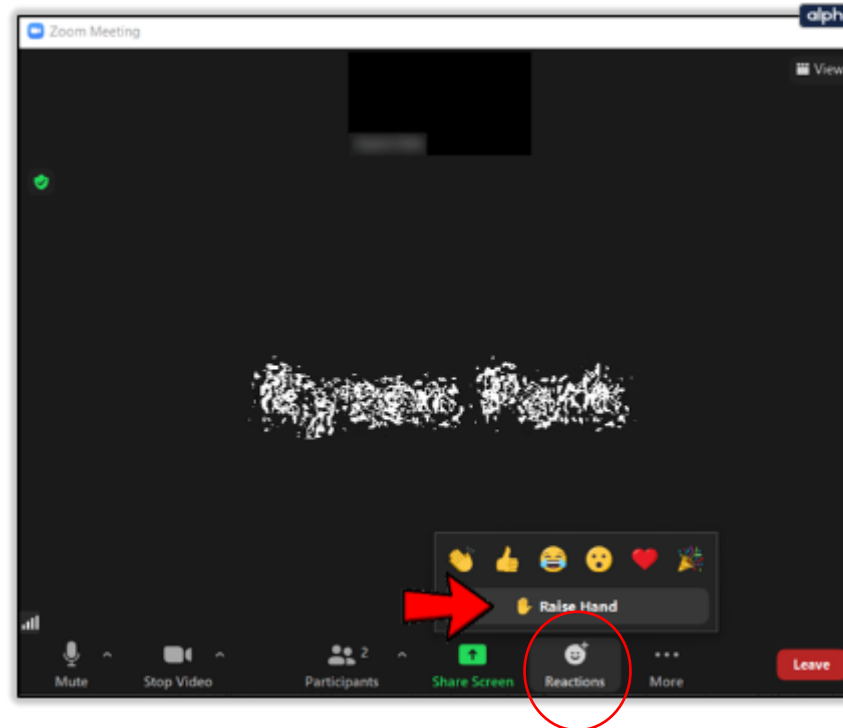

# Approach



# City of Stamford Goals

---

## Roadway Improvement Plan

- Traffic improvements to Burdick St, Belltown Rd and Upland Rd.
- Pedestrian improvements to Burdick St, Belltown Rd and Upland Rd.

## Park Improvement Plan

- Upgrades to existing pavilion, Park building, baseball facilities
- Improve site circulation Upgrade the stone walls, Consider new park features

## Playground Improvement Plan

- 2-5 & 5-12 play areas, Appropriate surfacing
- Adequate Grading and Drainage
- Site fencing (if appropriate)

# Roadway Improvement Plan





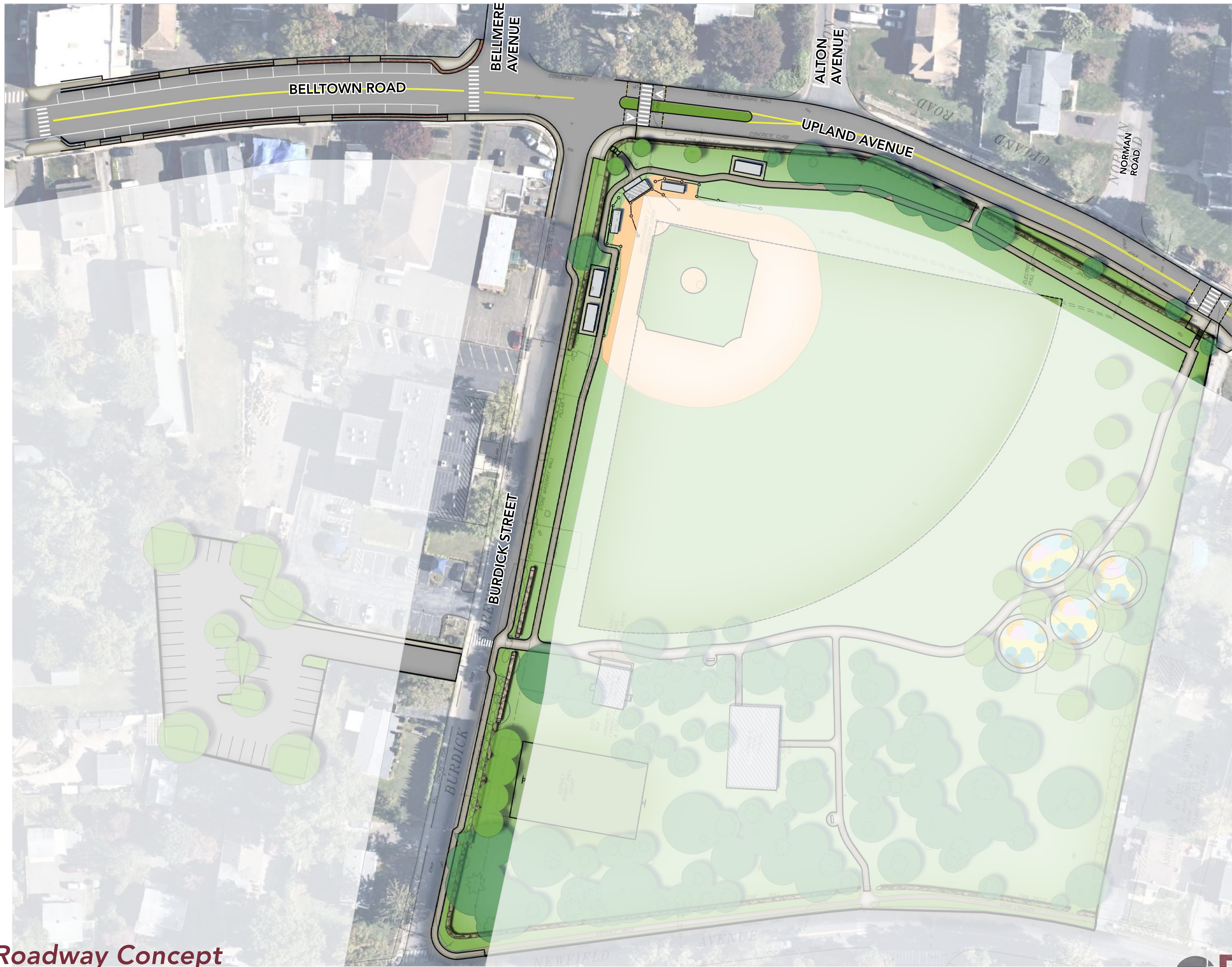

# Roadway Concept





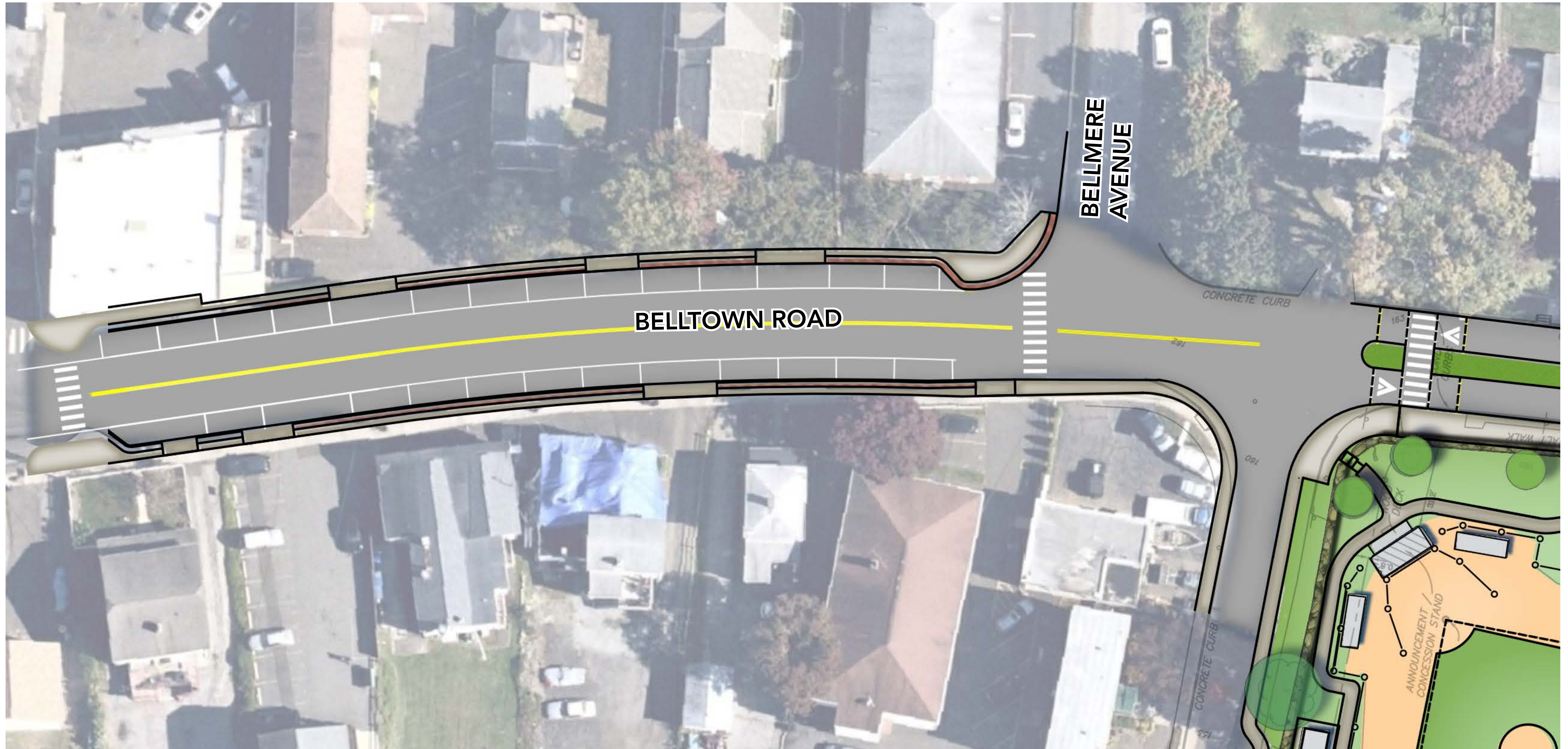

## ***Belldtown Road Enlargement***

Parks Master Improvements Plan | City of Stamford

March 2022

Stamford, CT





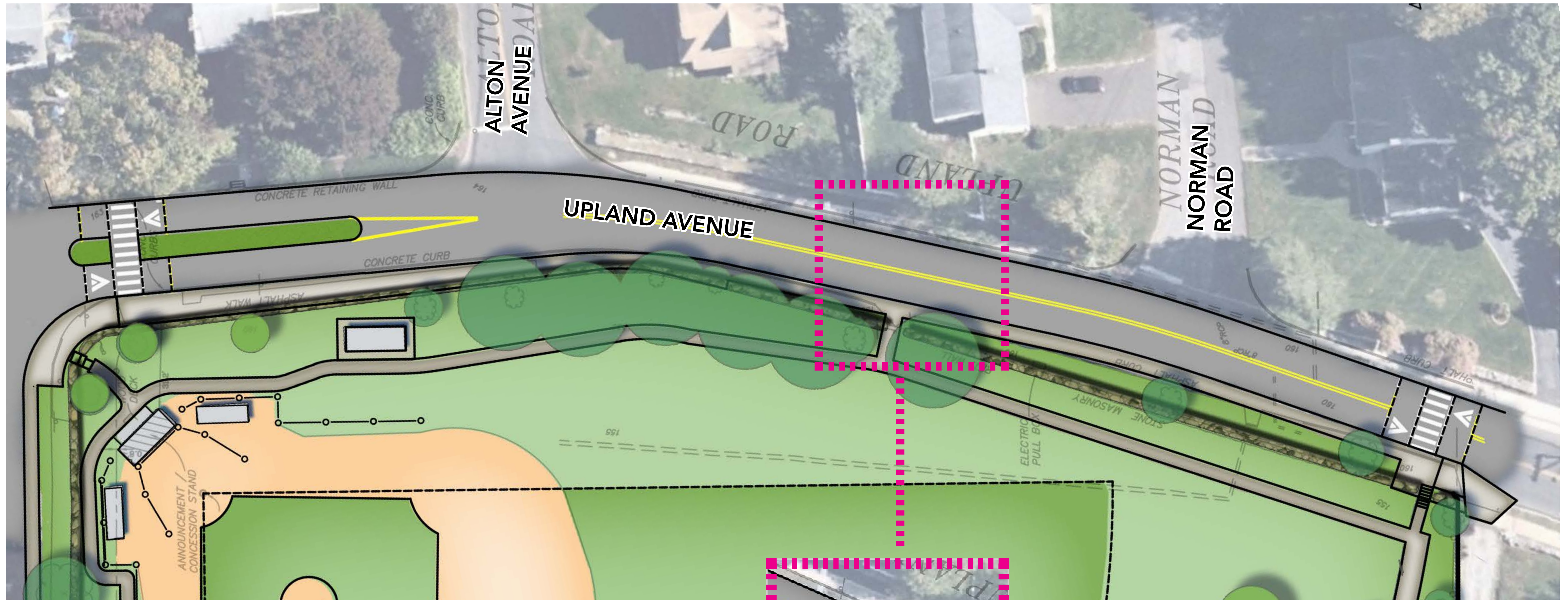

Crosswalk Location Alternate



## Upland Avenue Enlargement

Parks Master Improvements Plan | City of Stamford

March 2022

Stamford, CT







## Burdick Street Enlargement

Parks Master Improvements Plan | City of Stamford

March 2022

Stamford, CT





# Park Improvement Plan



Parking

Basketball  
Restrooms

Pavillion

Baseball Field

Play Area





# Baseball Field

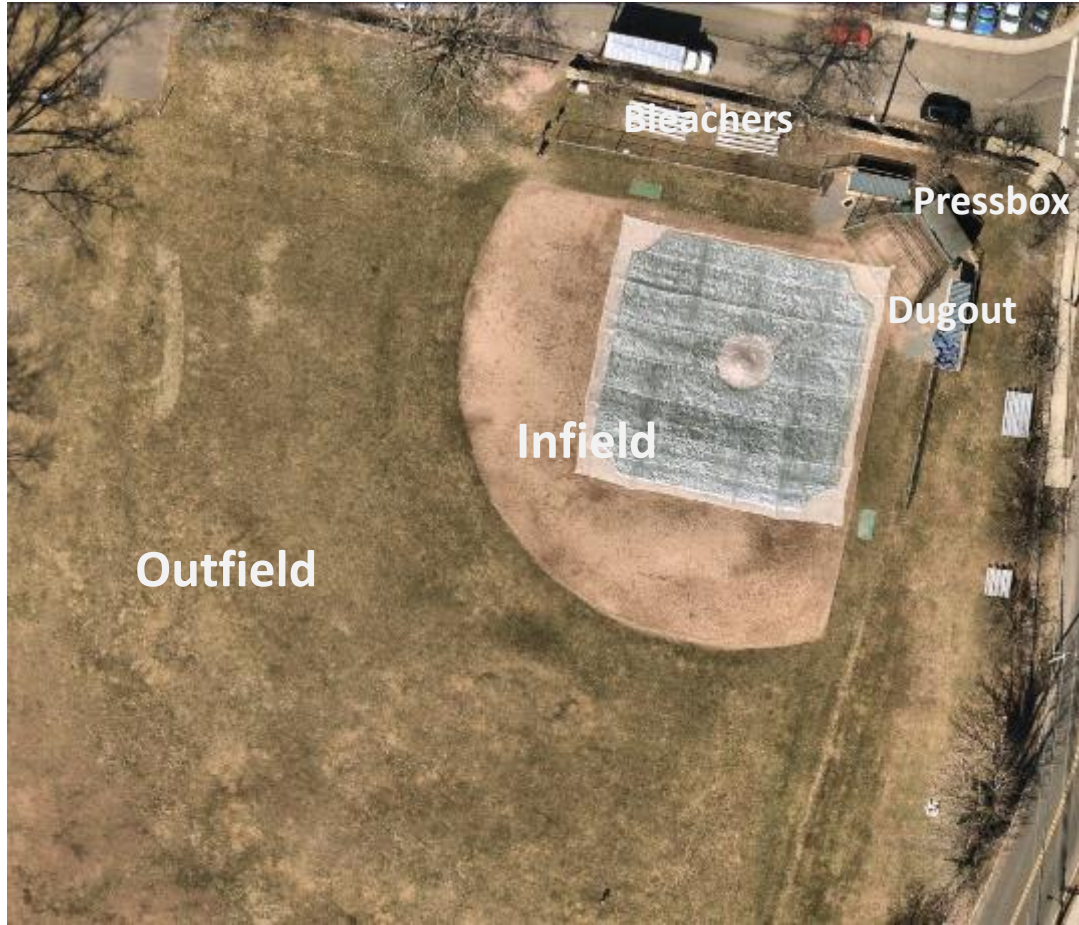



# Park Building, Pavilion, Basketball Court

---





# Park Building, Pavilion, Basketball Court





# Parking Area

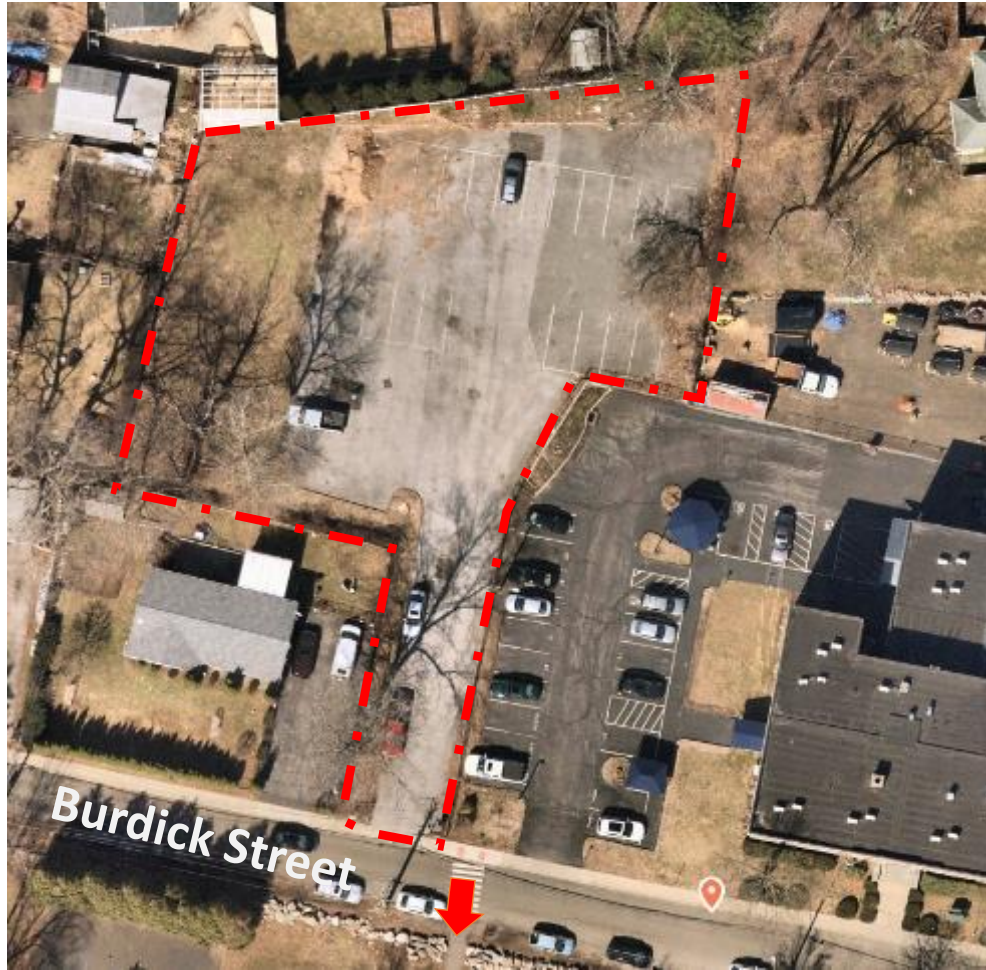

# Survey: What do you like best about Barrett Park?

---

## This is what we have heard so far:

- Open green space
- Love the 'nature' feel
- The community feel
- Trees, rocks, and grass
- Walking path
- The pavilion
- Multi-use area
- Shady benches
- Baseball field
- Basketball court
- Playground

# What would improve Barrett Park?

---

## This is what we have heard so far:

- Improved playground
- A track/ a path to walk around in a circuit
- Improve accessibility/crosswalks
- Sidewalk Improvements
- A ramp from upland into the park
- More benches/seating/picnic tables
- Tables with games on them/Ping pong
- Hammocks! Cool sitting areas!
- Better grills
- bike racks
- Additional trash cans
- Shade/More trees!
- Lawn improvements
- Repair basketball hoops
- Better bathroom facilities.
- Better lighting/security
- Improvements to scoreboard
- Repair stone walls
- Pickleball courts, Bocce court
- Splash pad
- Exercise stations
- Community garden
- Dog run
- Gazebos



# What do you wish there was less of/do not prefer to have in Barrett Park?

---

- Puddles/mud/standing water
- Drainage
  
- Litter
- Noise
  
- Dog park
- Splash pad
  
- parking on Burdick Street (needs improvement)
  
- Additional fenced in areas.





**Goals:**

1. Develop new universal access playground
2. Drainage Improvements
3. Develop path around park
4. Develop new walk off of Upland Ave
5. Develop new sidewalk extending into the roadway 5' to avoid impacting existing trees
6. Widen existing walk to from 5' to 8' to accommodate future use
7. Accessible ramp to restrooms, expand landing area as needed
8. Provide additional seating and recycling/trash units along walks
9. Invasive Species Management
10. Evaluate and renovate existing buildings
11. Improve parking area; restripe and provide lighting
12. Provide parking and sidewalk along Burdick St
13. Improve basketball court
14. Enhance baseball field with new fence mesh, bleachers and bleached pads, update dugouts and press-box
15. Inspect irrigation system and update as needed.
16. Provide continued lawn improvements at outfield and infield
17. Repair scoreboard
18. Rebuild wall
19. Adjust location of entry sign
20. Add drop off



**Park Concept- Option 1**







**Goals:**

1. Develop new universal access playground
- 2. Provide splash pad**
3. Drainage Improvements
4. Develop path around park
5. Develop new walk off of Upland Ave
6. Develop new sidewalk extending into the roadway 5' to avoid impacting existing trees
7. Widen existing walk to from 5' to 8' to accommodate future use
8. Accessible ramp to restrooms, expand landing area as needed
- 9. Incorporate fitness areas along walk**
10. Provide additional seating and recycling/trash units along walks
- 11. Enhance neighborhood connection at Newfield Ave**
12. Evaluate and renovate existing buildings
13. Improve parking area; restripe and provide lighting,
14. Provide parking and sidewalk along Burdick St
15. Provide lighting along entries
16. Improve basketball court
17. Enhance baseball field with new fence mesh, bleachers and bleached pads, update dugouts and press-box
18. Inspect irrigation system and update as needed.
19. Provide continued lawn improvements at outfield and infield
20. Repair scoreboard
21. Rebuild wall
22. Adjust location of entry sign
- 23. Develop Unstructured Play area with rocks, seating areas, and trees**
- 24. Develop "Adventure Play" with berms, paths, plantings, and hills**
25. Invasive Species Management
- 26. Develop dog park**



**Park Concept - Option 2**





# Playground Improvement Plan



## City of Stamford Goals - Playground

- 2-5 & 5-12 play areas
- Appropriate surfacing
- Adequate Grading and Drainage
- Site fencing (if appropriate)



# Playground

---

## Early Questions

- What features would you like to see in this play area?
- Are there unique historical characteristics, a color scheme or theme you'd like to incorporate?

## What we have heard so far:

- Climbing equipment
- Play structures
- obstacle course, zip line, ropes, ninja challenge
- Baby swings and big kid swings
- Areas for different ages
- complex/interesting equipment
- ADA accessible
- Shade above playground
- benches surrounding the play areas
- splash pad
- ADA surfacing
- Nature-themed setting





## Playground Concept - Nature Based Play Elements

Parks Master Improvements Plan | City of Stamford

March 2022

Stamford, CT





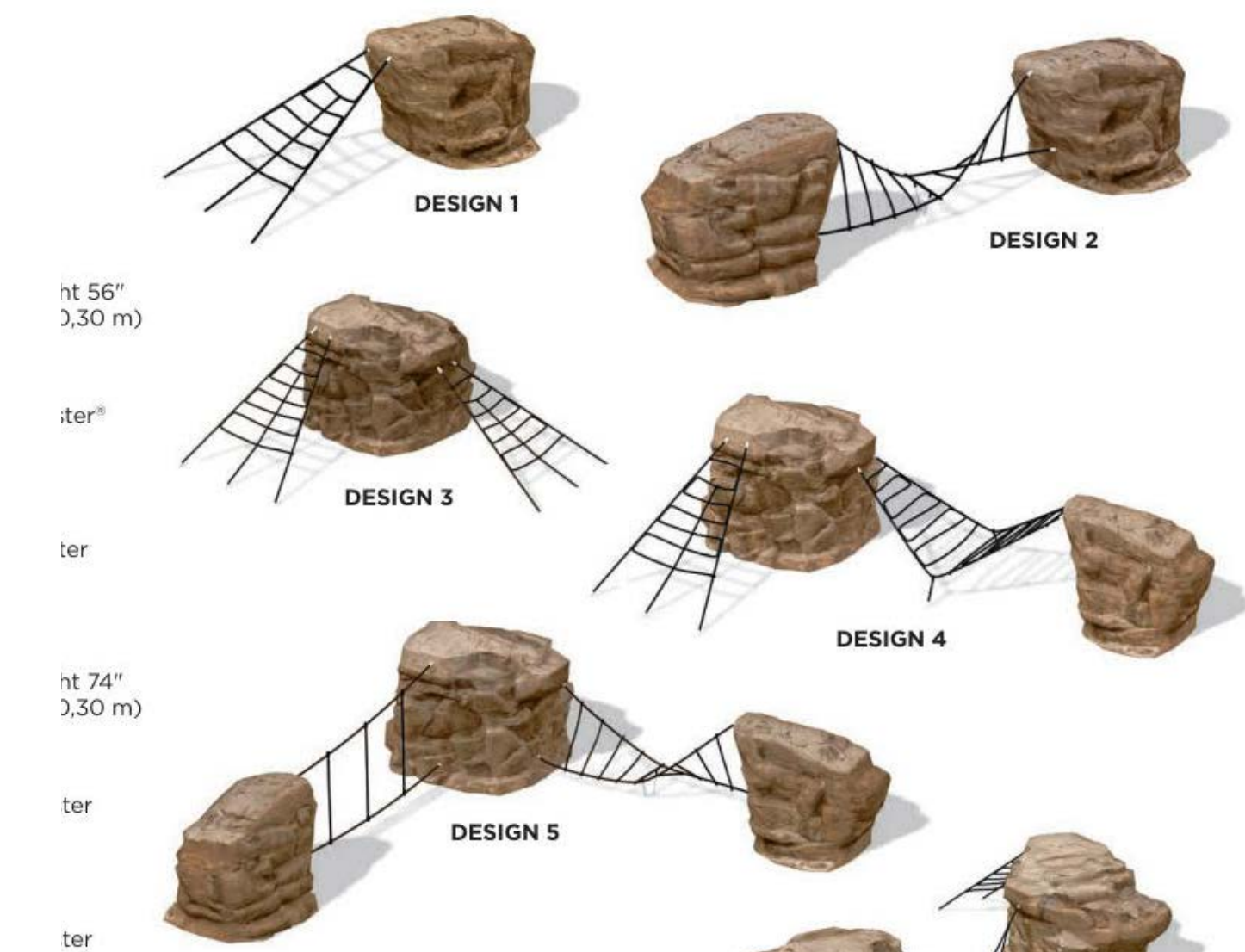

## Playground Concept - Option 1

Parks Master Improvements Plan | City of Stamford

March 2022

Stamford, CT





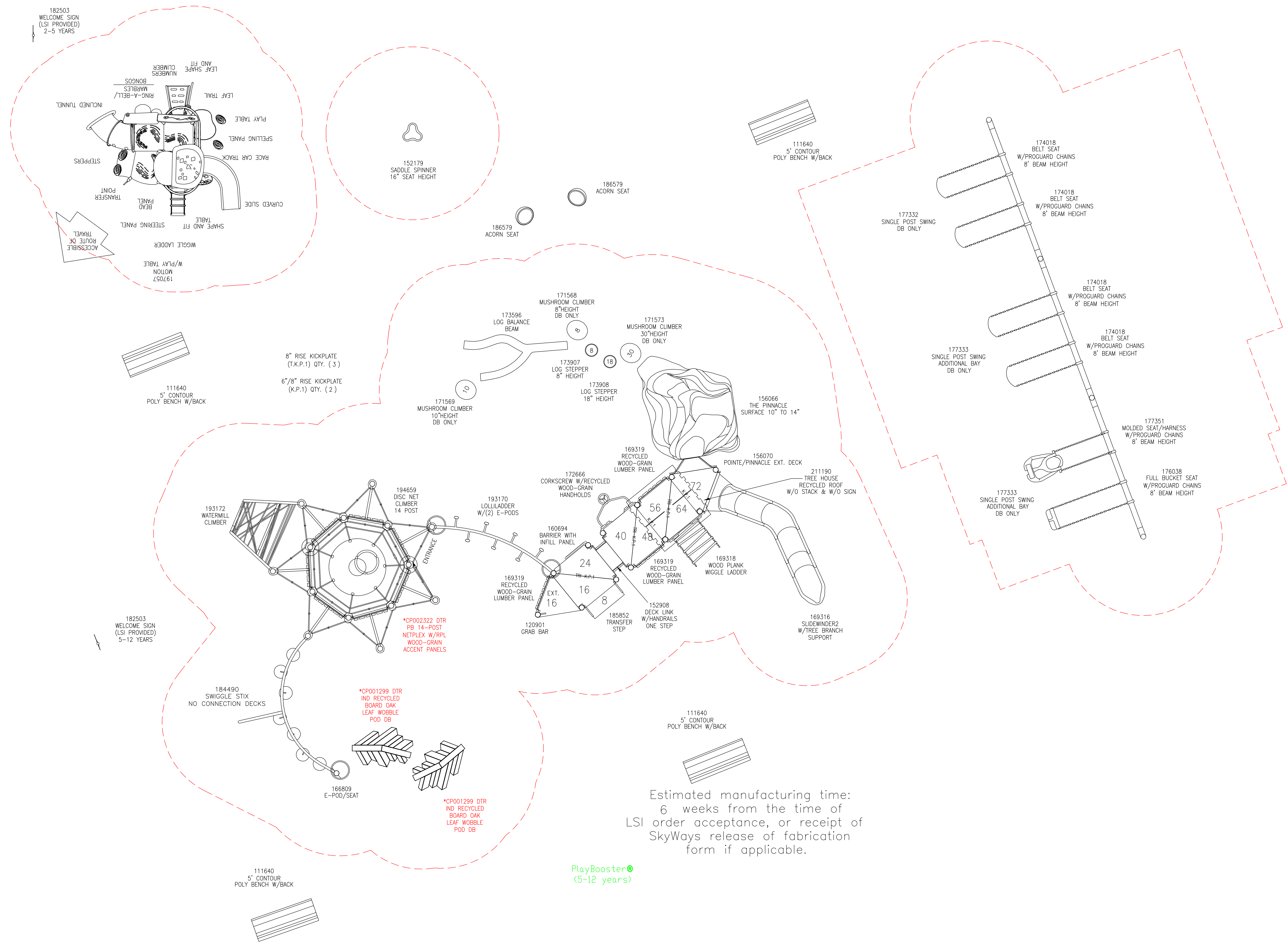

# Playground Concept - Option 1 - Plan

Parks Master Improvements Plan | City of Stamford

March 2022

Stamford, CT







## ***Playground Concept - Option 2***

Parks Master Improvements Plan | City of Stamford

March 2022

Stamford, CT





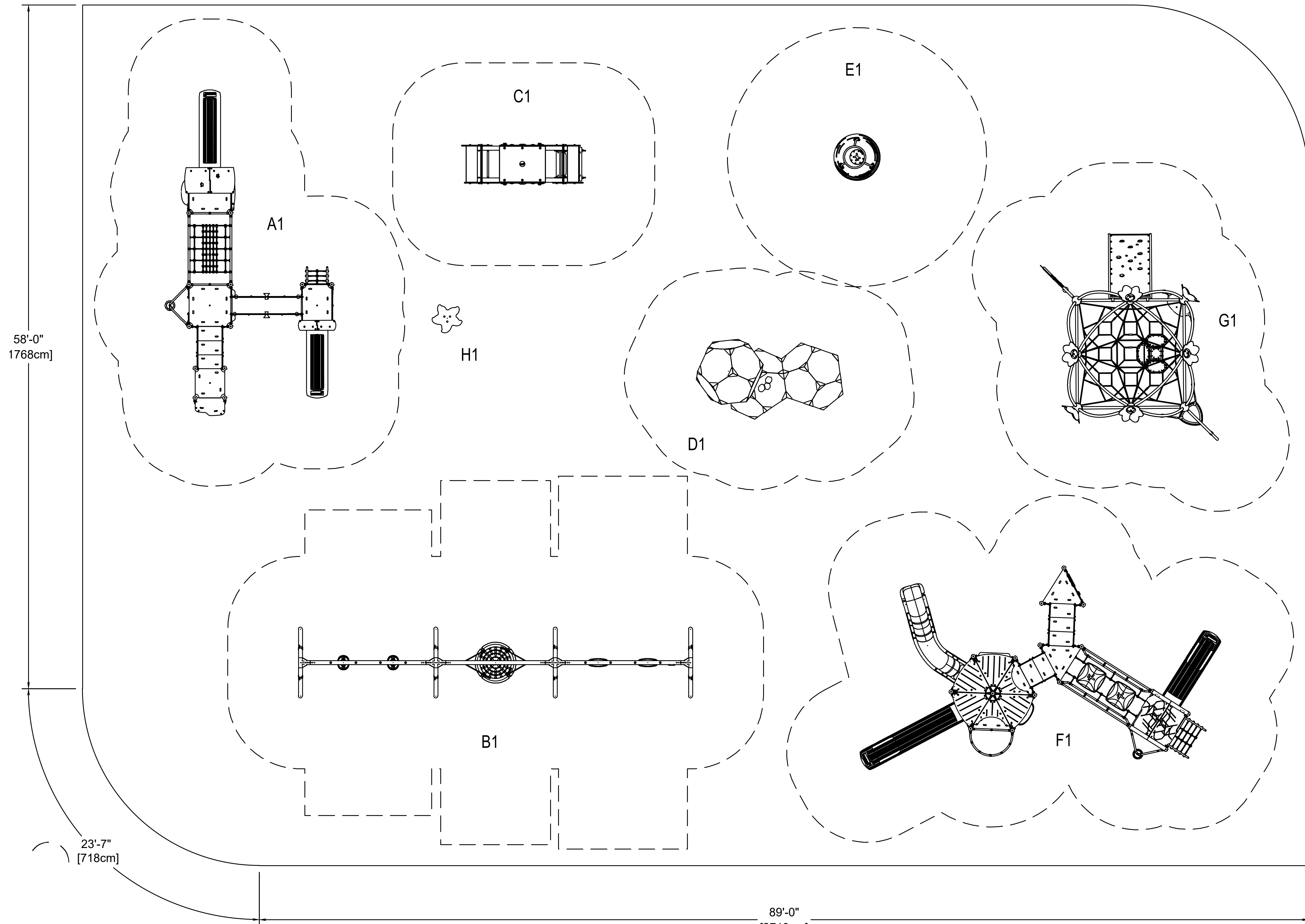

## Playground Concept - Option 2

Parks Master Improvements Plan | City of Stamford

March 2022

Stamford, CT





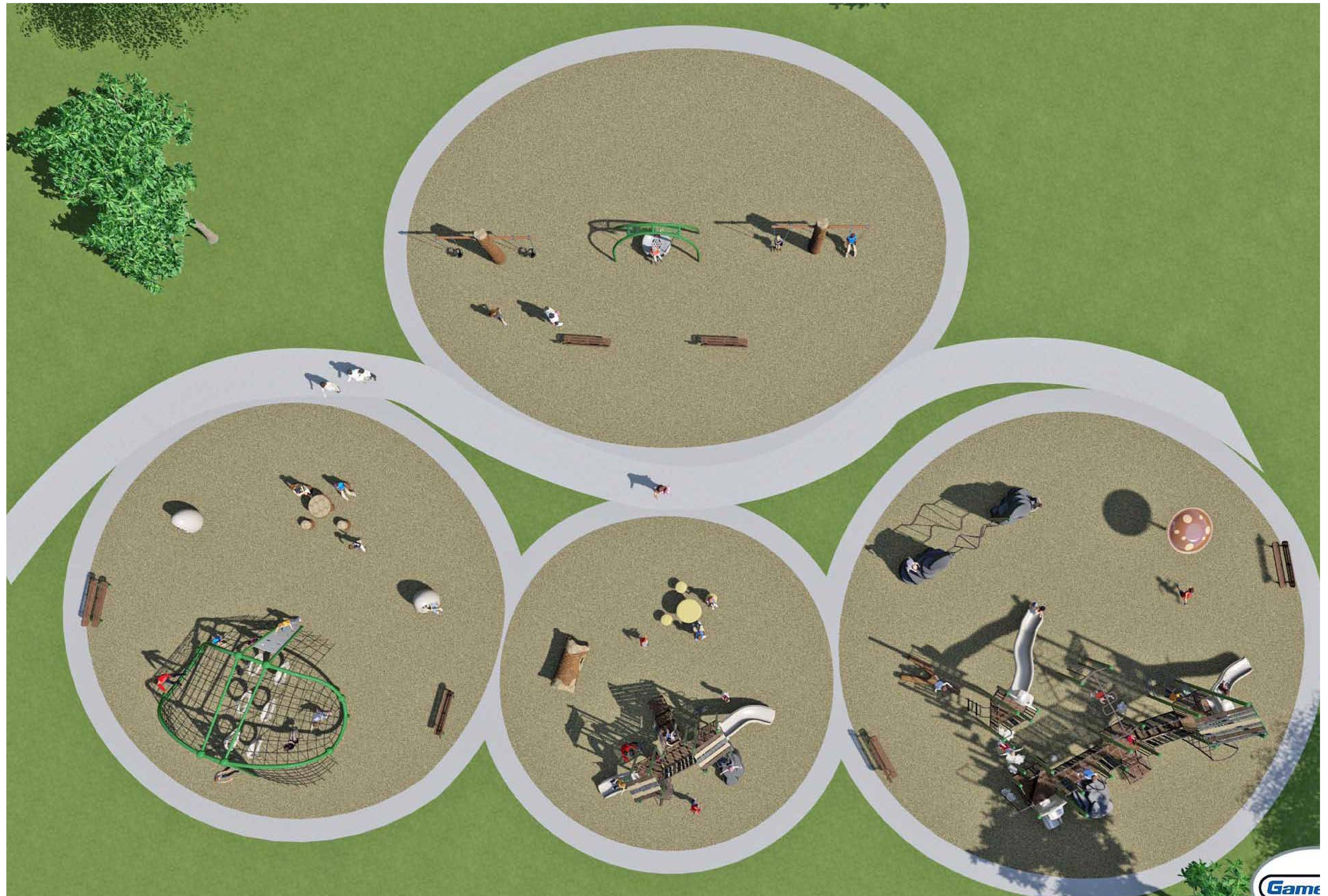

## Playground Concept - Option 3

Parks Master Improvements Plan | City of Stamford

March 2022

Stamford, CT







## Playground Concept - Option 3

Parks Master Improvements Plan | City of Stamford

March 2022

Stamford, CT







## ***Playground Concept - Option 4***

Parks Master Improvements Plan | City of Stamford

March 2022

Stamford, CT





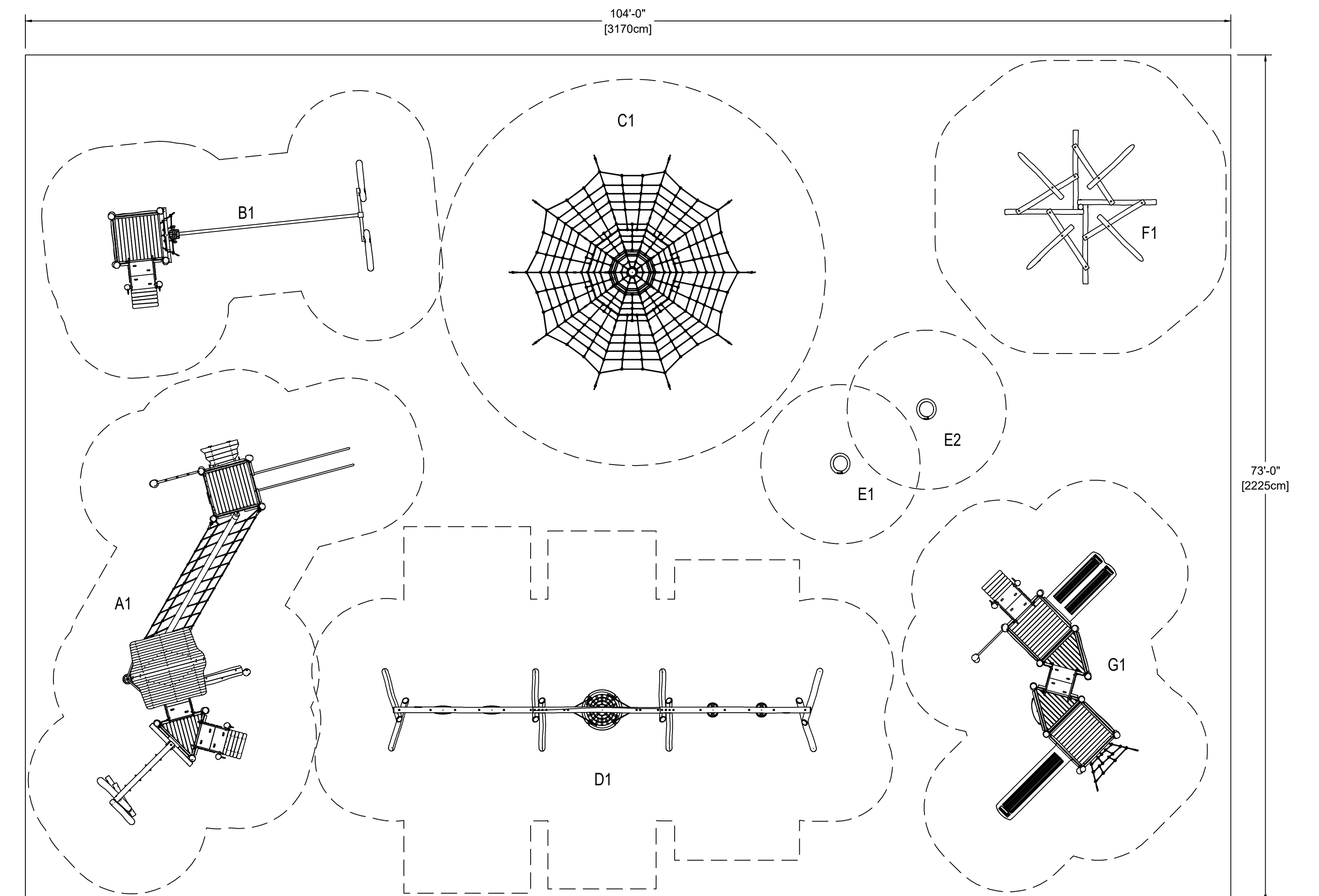

## Playground Concept - Option 2

Parks Master Improvements Plan | City of Stamford

March 2022

Stamford, CT





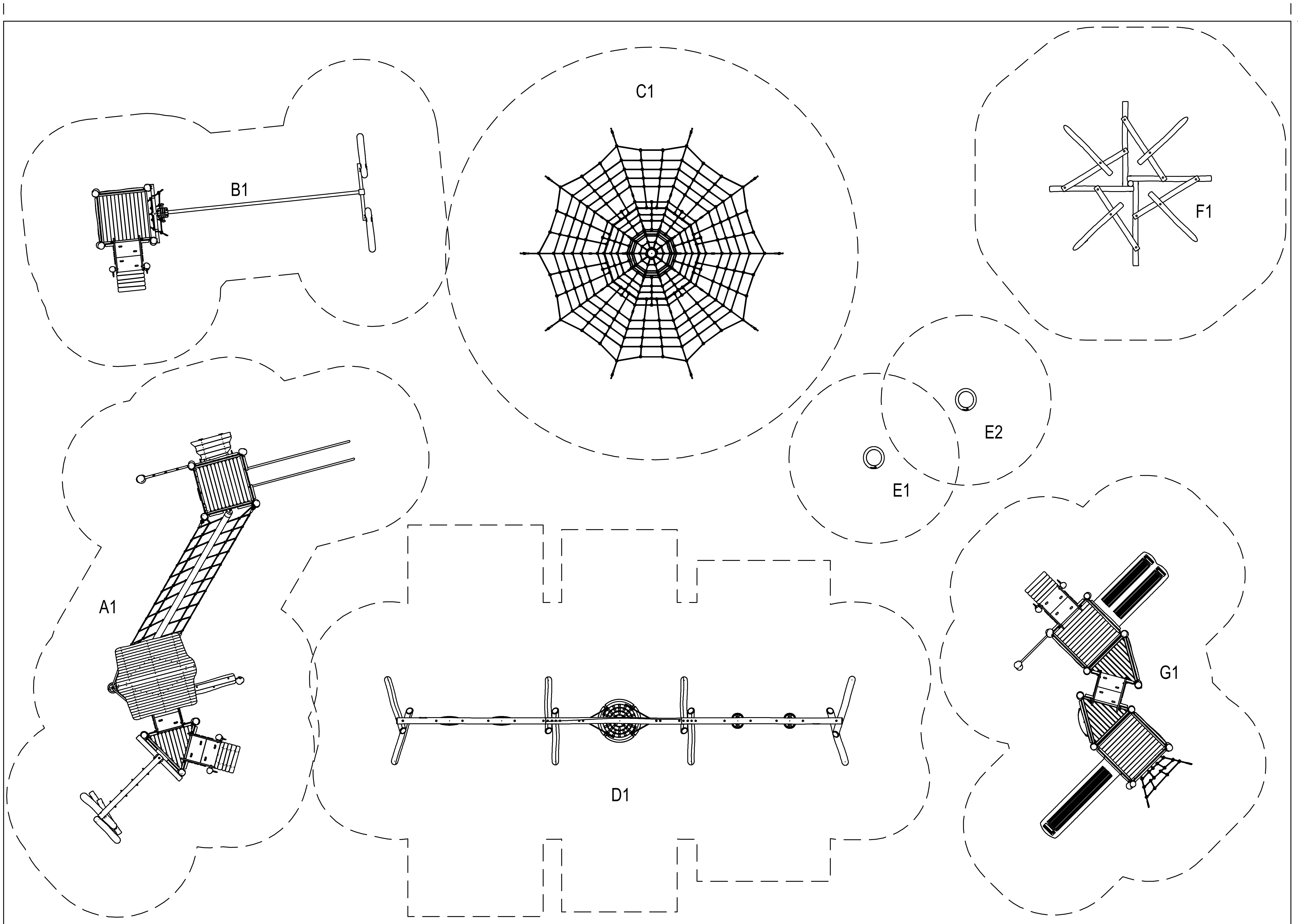

**Playground Concept - Option 4**

Parks Master Improvements Plan | City of Stamford

March 2022

Stamford, CT







## Playground Concept - Option 4

Parks Master Improvements Plan | City of Stamford

March 2022

Stamford, CT





# Listening and Discussion

---

Help us improve a great park.  
Let us know what matters to you.



# Thank You

---

Next Meeting TBD

For questions and concerns contact:

**Erin McKenna**

Project Manager | City of Stamford

[EMcKenna@StamfordCT.gov](mailto:EMcKenna@StamfordCT.gov)